

Modeling Of Self-Organization Fish School System By Neural Network System

Mofeed T. Rashid

Department of electrical Engineering
University of Basrah
College of Engineering
mofid76@yahoo.com
mofeed.t.rashid@ieee.org

Abstract- In this paper, a Neural Network (NN) model system for self-organization fish school system is identified. Monitoring and data extraction from fish school video has been achieved by using image processing technique in order to generate the data suitable for parameter identification of NN model system. Data obtained have been used to identify the parameters of a model based on a black-box represented by nonlinear autoregressive exogenous model (NARX). The obtained results show that this system can be used for multi robot formation system.

Keywords Self organizing, Fish school, Neural network model, NARX model.

I. Introduction

In recent years, multi robot systems become very interesting for researchers since the significant of these systems increased in a lot of applications like industrial, commercial and scientific applications. Designing a strategy for controlling the localization of each individual in the system to achieve formation model for multi robot system is the main challenge. Understanding and modeling the relative mechanisms and operational principles of collective behavior of a population of animals which represented by flock is a source of inspiration for multi-agent control strategies [1]. In nature, flocking is an ubiquitous self-organized phenomenon which all individuals move as a group, keep a distance from each other, and avoid obstacles or enemies. The modeling of the flock may therefore provide useful idea for developing formation control, distributed cooperative control and coordination of multiple mobile autonomous agents/robots [2][3].

Many researchers have tried to understand the behavior of each individual in an animal group from a theoretical perspective in order to derive a mathematical model describes collective behavior of this group. Breder (1951) discussed the possibility of deriving physical equations for fish school model which a typical fish school shows clear evidence of both attraction and repulsion between the individual fishes [4]. One of the well-known models is "Boid" reported by Reynolds [5] which introduced a simple rule in each element of individuals flock and showed they behave just like real birds. Sannomiya et al. explained the behavior of the school of an actual fish by introducing simple interaction [6]. Vicsek et al. reported the group behavior of real bacteria by simple model [7]. This model is simple, but it explains the phase transition of the actual bacteria's behavior well, and some researchers have analyzed this model from control engineering viewpoint [8].

In this paper, the self-organizing of four individuals of the fish school will be modeled by using a black box. The neural network parameter identification model represented by NARX model [9] has been used as the black box. Image processing will be used for extracting the coordinates of individuals in the video. The x-y coordinates of the school individuals represented the system output while the path coordinate of the fish school represented the input of the system.

II. Extracting Data from Fish Flock System

The recorded video of fish flock compounds of 1672 frames, RGB24 bit color system and each frame dimension is 320×240 pixels. This video emulates the motion behavior of the fish school which fish perform self-organizing during the movement. Image processing techniques have been used to extract the fish school trajectories, as well as important information on fish motion from the recordings as shown in Fig.1.

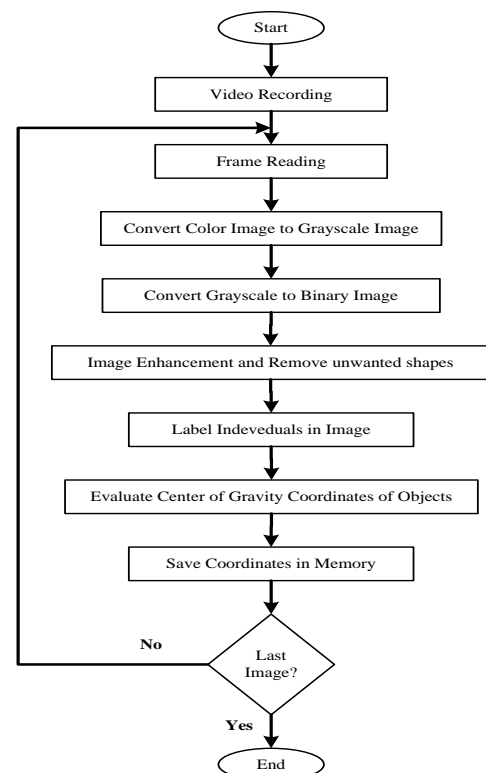

Fig. 1 Block Diagram of extracting data from video.

The video has been analyzed frame by frame in sequence which each frame has been enhanced and then converted to a grayscale image. For high accurate conversion, adaptive binarization algorithm is used to convert grayscale image to binary image. In this case, there is no universal threshold

value of the whole image, but for each pixel its own threshold value is calculated separately depending on pixel location which is the average value of intensity of the neighborhood pixel block. If the gray value of the pixel is greater than the threshold, then it is set to white, otherwise it is set to black.

Morphological operations have been used for removing unwanted shapes (noise) in binary image; and modifying the boundaries of fish shapes for accurate recognition. Finally, labeling has been performed in order to evaluate the center of gravity of each individual in the frame as shown in Fig. 2.



(a) Frame sample



(b) Grayscale image

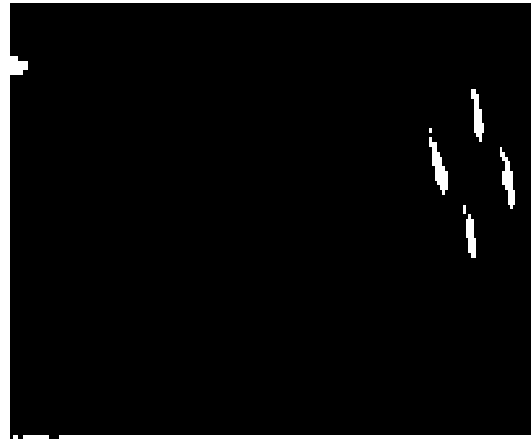

(c) Binary Image

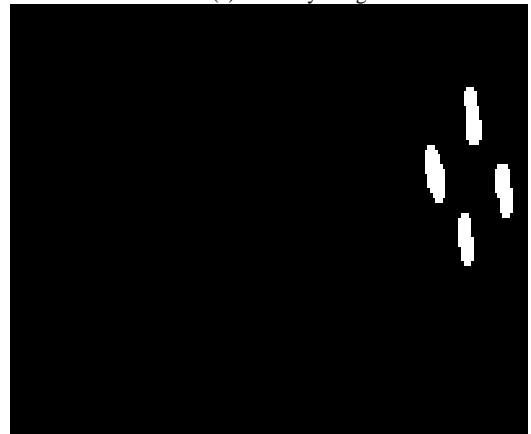

(d) Applying morphology

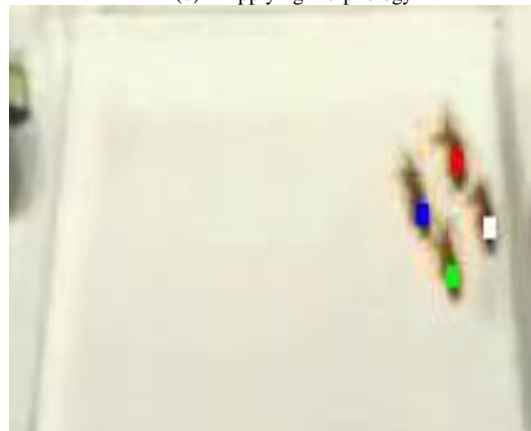

(e) Labeled image

Fig. 2 Continued.

Fig. 2 Image processing steps for information extraction

The trajectory extraction of each individual has been performed by concatenating the coordinates of each individual for all frames in the video which is shown in Fig. 3. While x and y coordinate plots are shown in Fig. 4.

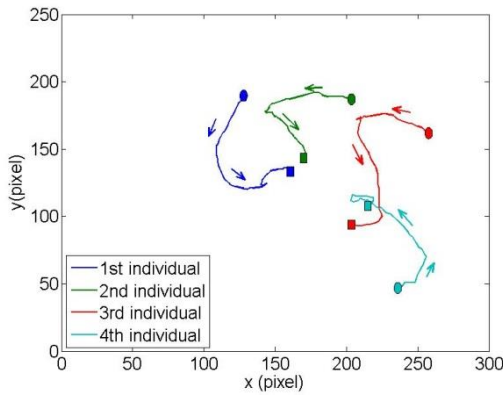

Fig. 3 Fish trajectories

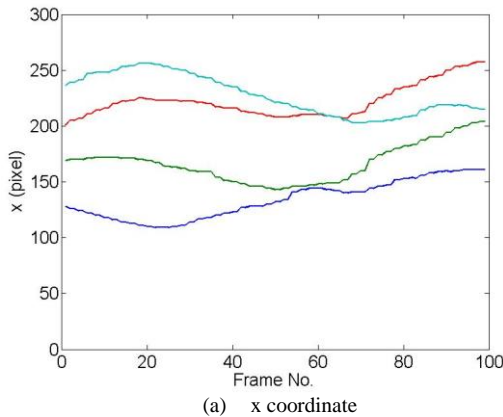

Fig. 4 x and y Coordinates of each individual of fish school.

III. Neural Network Model

System identification is the process of developing a mathematical model of a dynamic system based on the input and output data from the actual process. System identification allows a real system to be altered without having to calculate the dynamical equations and model [10]. Recent results show that the neural network techniques seem to be very effective to identify a wide class of complex nonlinear systems when no complete model information available, or even when the controlled plant has been considered as a black box [11].

In this section, a black-box nonlinear model has been considered. In particular, a NARX neural model has been derived. The defining equation for the NARX model is [9]

$$\begin{aligned}
 x_i(t) &= f(x_i(t-1), x_i(t-2), \dots, x_i(t-n_{x_t}), x_t(t-1), x_t(t-2), \dots, x_t(t-n_{x_t})) \dots\dots\dots(1) \\
 y_i(t) &= f(y_i(t-1), y_i(t-2), \dots, y_i(t-n_{y_t}), y_t(t-1), y_t(t-2))
 \end{aligned}$$

$$\dots, y_t(t-n_{y_t})) \dots\dots\dots(2)$$

Where x_i, y_i are the x-coordinate and y-coordinate of each individual while x_t, y_t are the x-coordinate and y-coordinate of fish school trajectory, respectively. A diagram of the NARX model is shown in Fig. 5, where a two-layer feed forward network is used for the approximation. This implementation also allows for a vector autoregressive exogenous model (ARX), where the input and output can be multidimensional [9].

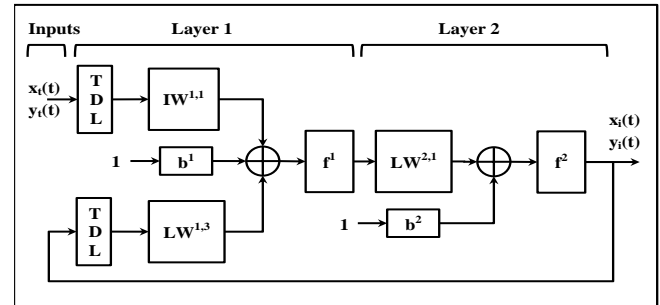

Fig. 5 NARX neural network model [9].

A one-hidden-layer multilayer perceptron with sigmoidal activation functions coupled with a linear block has been trained with the same data shown in Fig. 4 by using the system identification toolbox of MATLAB®. The best performances have been obtained with 10 hidden units for $x_i(t)$ and 15 hidden units for $y_i(t)$.

IV. Results of Simulation Model

The NN model has been simulated by MATLAB which is the fish school system. This model is divided into eight systems; four systems for x coordinates of individuals while the other four are y coordinates of individuals in fish school system. The inputs of each individual system represented by the coordinate of flock trajectory and coordinates of other individuals while output of each system is the coordinate of individual.

In Fig. 6 the performance of the NN model on the learning trajectory for both x and y components of the trajectory is shown. Fig. 7 shows the output of the NN model when the testing trajectory is used.

As shown in Fig. 7 the performance obtained with the NN model is seems similar to that of the fish school model, so NN model is a good approach for representation a complex system and can be used for modeled the behavior of individuals in a complex system.

V. Conclusion

The NN model has been used for modeled the self-organization of fish flock system. The system is divided into eight systems for more simplicity. By observing the results that shown in Fig. 6 and Fig. 7, it can be concluded that this system is suitable to emulate the behavior of each individual in fish flock in order to obtain fish school system. The NN model can be learned by several pattern of fish school

trajectories in order to use as group formation system suitable for multi robot system.

VI. References

- [1] T. Vicsek, A. Czirok, E. Ben-Jacob, I. Cohen, and O. Shochet, "Novel type of phase transitions in a system of selfdriven particles", *Physical Review Letters*, vol. 75, pp. 1226–1229, 1995.
- [2] R. Olfati-Saber, "Flocking for multi-agent dynamic systems: algorithms and theory", *IEEE Trans. Automatic Control*, vol. 51, pp. 401–420, 2006.
- [3] B. Lei, W. Li, and F. Zhang, "Flocking Algorithm for Multi-Robots Formation Control With a Target Steering Agent", 2008 IEEE International Conference on Systems, Man and Cybernetics (SMC 2008).
- [4] C. M. Breder, "Equations Descriptive of Fish Schools and Other Animal Aggregations", *Ecology, Ecological Society of America*, vol. 35, No. 3, pp.361-370, Jul. 1954.
- [5] <http://www.red3d.com/cwr/boids/>
- [6] N. Sannomiya, "Fish Behavior Model", *Suurikagaku*, No. 432, pp. 61-67, 1999.
- [7] T. Vicsek, A. Czirok, E. Ben-Jacob, I. Cohen, and O. Shochet, "Novel Type of Phase Transition in a System of Self-Driven Particles", *Phys. Rev. Lett.*, vol. 75, pp. 1226-1229, 1995.
- [8] A. Savkin, "Coordinated collective motion of groups of autonomous mobile robots: Analysis of Vicsek's model", *IEEE Trans. on Automatic Control*, vol. 49, No. 6, pp. 981-983, 2004.
- [9] <http://www.mathworks.com/help/nnet/ug/design-time-series-narx-feedback-neural-networks.html>.
- [10] E. J. Rzepoluck, "Neural network data analysis using Simulnet", Springer, 1998.
- [11] Yu W., and Li X., "Some New Results on System Identification with Dynamic Neural Networks", *IEEE Transactions on Neural Networks*, vol. 12, No. 2, 2001.

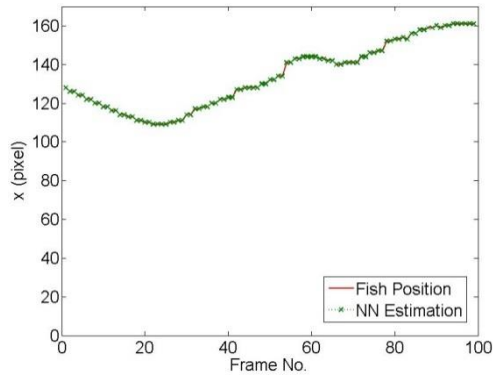

(a) x-coordinate of 1st individual.

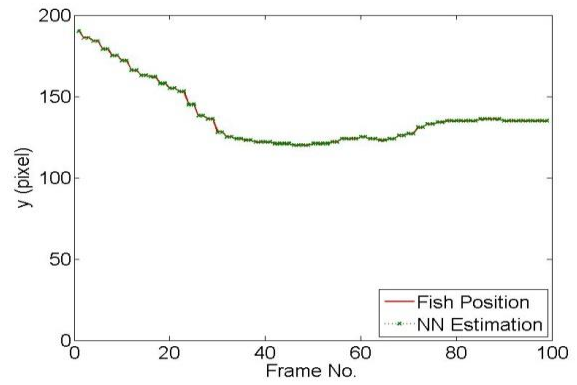

(e) y-coordinate of 1st individual.

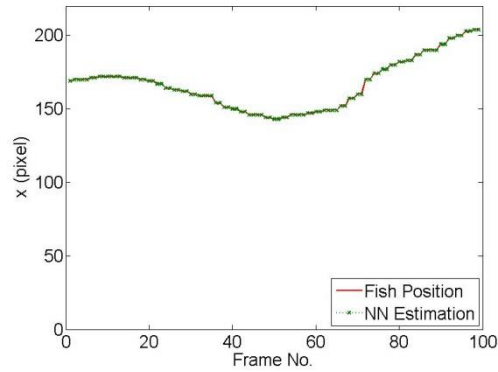

(b) x-coordinate of 2nd individual.

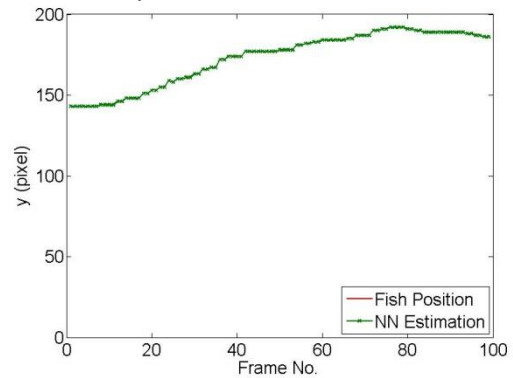

(f) y-coordinate of 2nd individual.

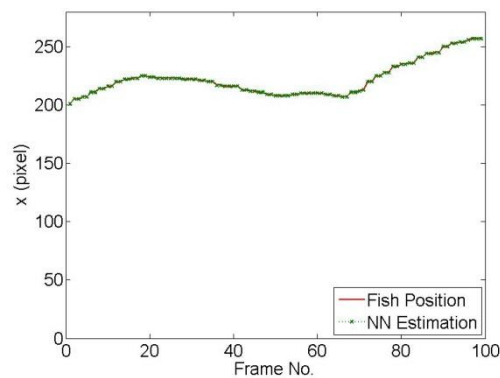

(c) x-coordinate of 3rd individual.

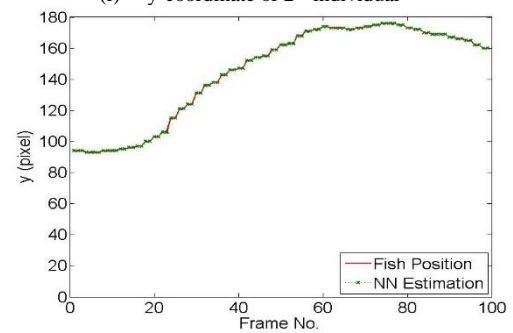

(g) y-coordinate of 3rd individual.

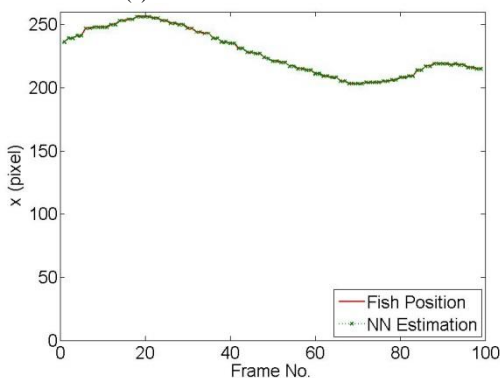

(d) x-coordinate of 4th individual.

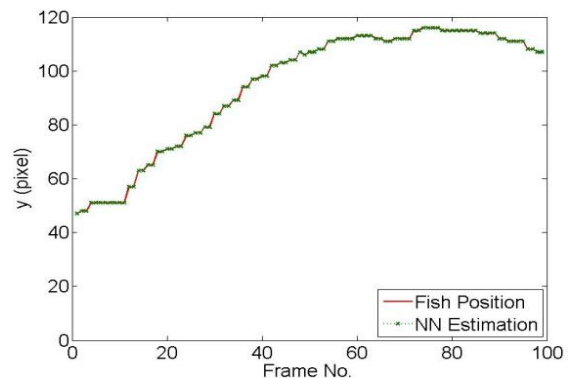

(h) y-coordinate of 4th individual.

Fig. 6 Learning trajectory and NN model output $x(t)$ and $y(t)$.

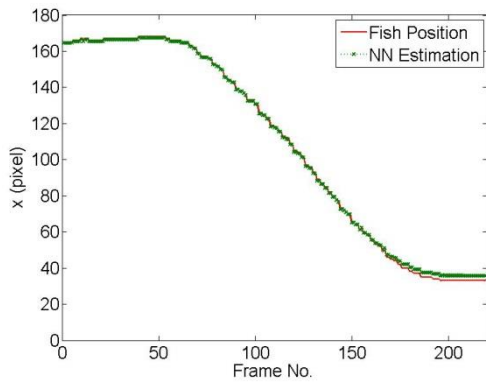

(a)x-coordinate of 1st individual.

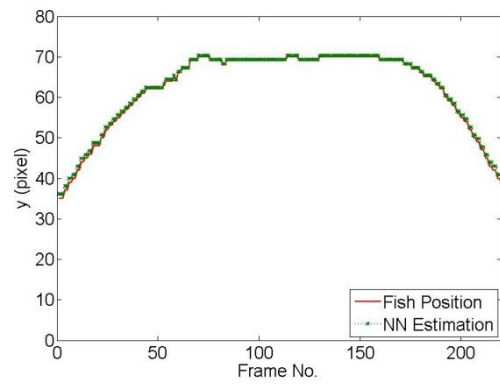

(e) y-coordinate of 1st individual.

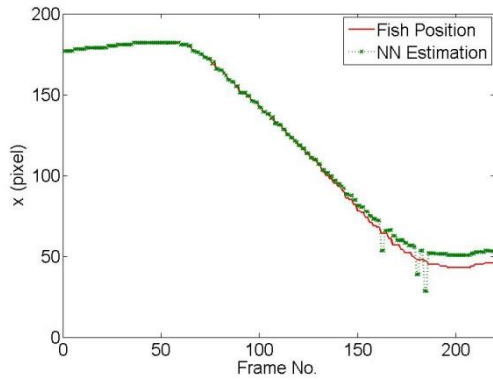

(b)x-coordinate of 2nd individual

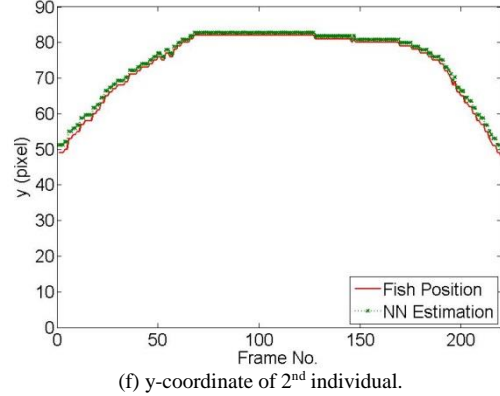

(f) y-coordinate of 2nd individual.

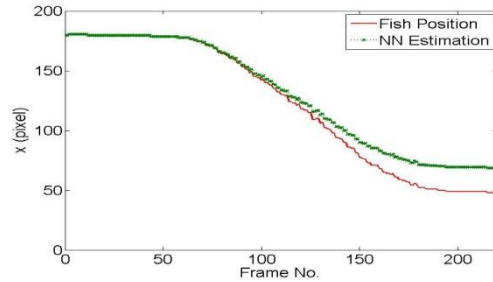

(c)x-coordinate of 3rd individual.

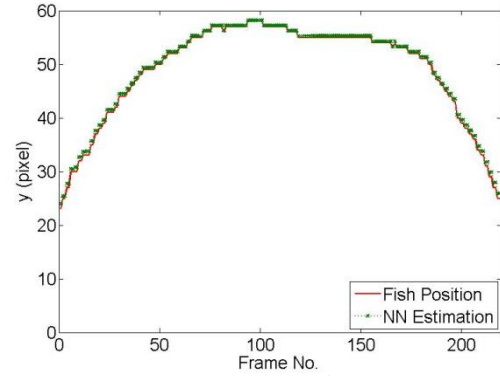

(g) y-coordinate of 3rd individual.

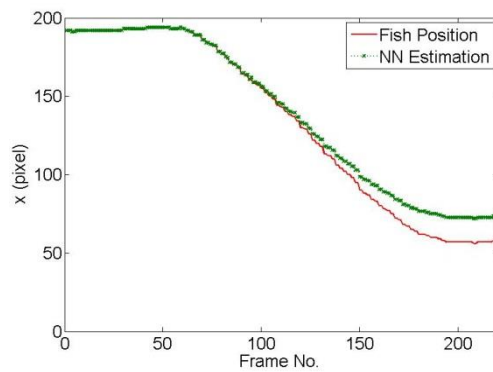

(d)x-coordinate of 4th individual.

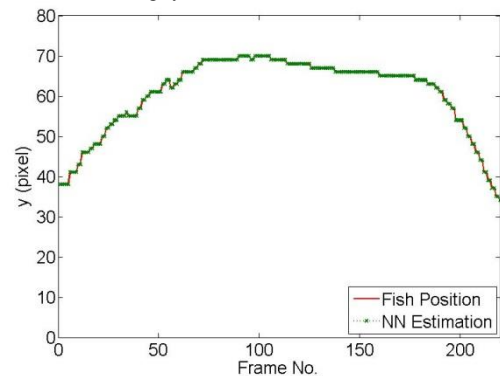

(h) y-coordinate of 4th individual.

Figure 7: Testing trajectory and NN model output $x(t)$ and $y(t)$.